



GATHER THESE TOOLS FOR ASSEMBLY & INSTALLATION
 7/16" wrench, 7/16" socket, 3/8" drive ratchet - 3/8" socket
 One 1/8" square end driver bit provided - Electric drill/driver/18V cordless
 One each; carpenters square, mallet, tension clamps
 One each; Phillips and blade screwdrivers, 9/32" drill bit, 1/2" wrench

Installation Instructions

1 Check contents against parts list. Examine contents for damage caused by shipping. Make sure that you have the required tools for assembly, as listed above. NOTE: Drawer Tray is assembled upside-down for ease.

2 Lay out the Drawer Side Rails with Pinch Point Sticker facing down, bearing track should be outward. NOTE: Drawer Tray is assembled upside-down and Support Rails will follow. Position the Rear Drawer Face opposite the end with the Pinch Point Stickers and use tension clamps to secure in place. (See Pic.1) Align pre-drilled holes and attach using the screws provided in Hardware Bag #1. (See Pic.1a & 1b).

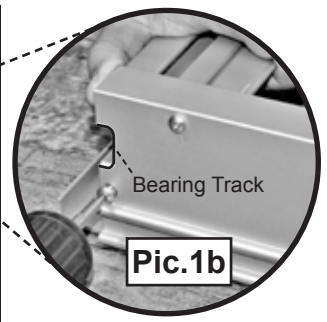

3 Starting with the Tray Cross Channel containing the Latch, loosen the nuts on the attached rail plates and insert into channel on Drawer Side Rail (See Pic.2a) and slide toward Rear Drawer Face stopping just beyond factory marks and tighten. (See Pic.2b) Latch should be located on right side of drawer. Repeat with the remaining two (2) Tray Cross Channels. (See Pic.2c)

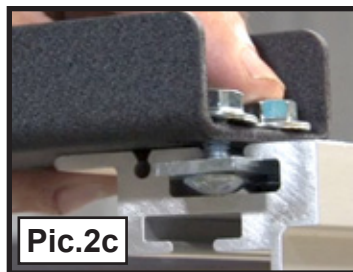
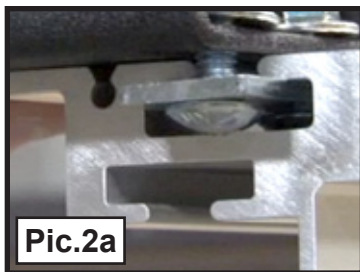

NOTE: The Latch on the Tray Cross Channel should be on your right side.

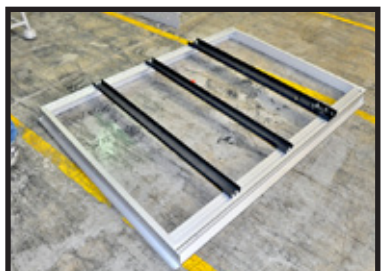
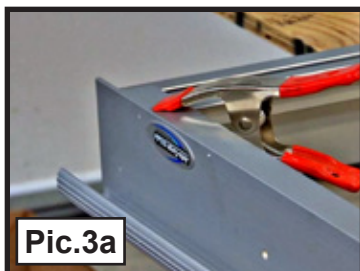

4 Attach the Drawer Pull / Face by aligning with pre-drilled holes using clamps and making sure that each Drawer Side Rail is located under the lip of the Drawer Pull / Face. (See Pic.3a) Using a electric drill/driver/18V cordless, drill screws into Drawer Pull/Face to secure. (See Pic.3b) Using ratchet and 7/16" socket, tighten the nuts on the Tray Cross Channels. Be sure to check your alignment with the factory marks. (See Pic.3c)

Jotto-Cargo Slide Installation Instructions

5 Remove the E-Clip (See Pic.4) from Latch Control Cable. Insert the Latch Control Cable through pre-drilled holes in center of first two(2) Tray Cross Channels. Run the Latch Control Cable through the appropriate hole on the Tray Cross Channel w/ Latch Assembly. (See Pic.5)

6 First, insert dog leg end of latch cable into latch pin assembly; may help to push in on pin assembly. (See Pic .6) Then, push cable into tab in cross channel and snap E-clip onto notch in cable. (See Pic.7)

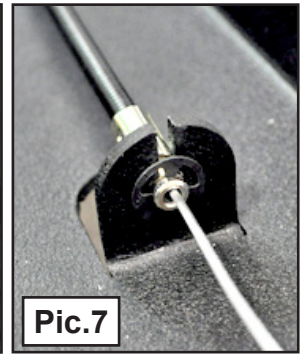
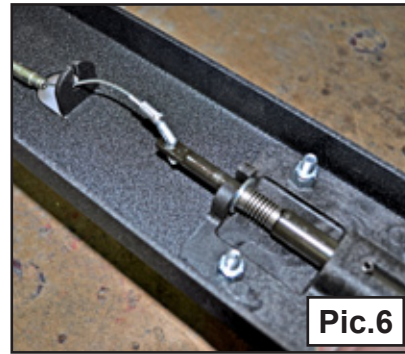
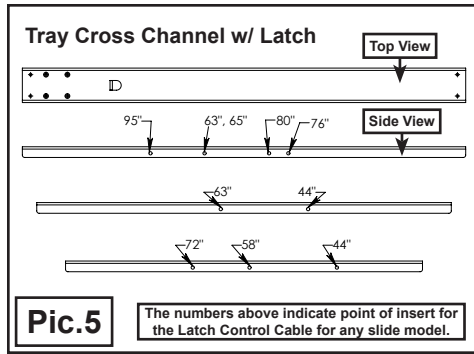

7 Insert screws and through Latch Control Cable bracket and pre-drilled holes on Drawer Pull / Face and secure with supplied Nylock Nuts using a phillips screw driver and wrench. NOTE: Nuts should attach to the bracket side. (See Pic.8 & Pic.9)

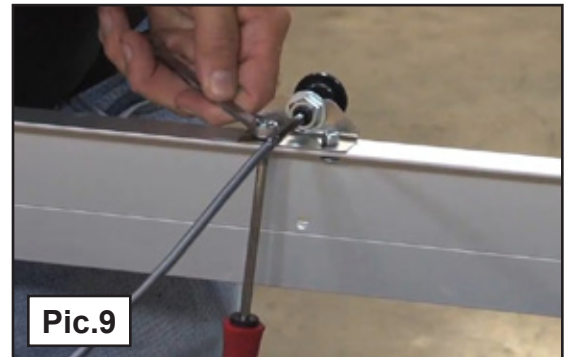

8 Once tray is assembled, slide each of the Frame Side Rails(2) into the track, channel side up. (See Pic.10) (NOTE: The latch must be disengaged to allow Frame Support Rail to slide fully into place.) With Frame Side Rails in place, slide the front Frame Support Rail with pre-attached rail plates into channel and push toward front, stopping at mark and repeat with center support. (See Pic.11)



Jotto-Cargo Slide Installation Instructions

9 Now slide one(1) support bracket into each channel toward the front and stop, then slide final Frame Support Rail in place for brackets. NOTE: All three(3) Tray Cross Channels come w/ pre-drilled holes. (See Pic.12-14) Align Frame Support Rail with factory mark, and tighten the 1/4-20 flange nuts. Using an electric drill/driver/18V cordless, drive the supplied screws in Bag#1 securing slide support bracket Frame Support Rail, then tighten down the 1/4-20 flange nuts. (See Pic.15-18) Insert and carefully tighten the (2) Radial Bearings in the area located under the Front Tray Cross Channel and the Drawer Pull/Face. (See Pic.19) Tap in the provided End Caps(6) into the Tray Cross Channels. (See Pic.20)

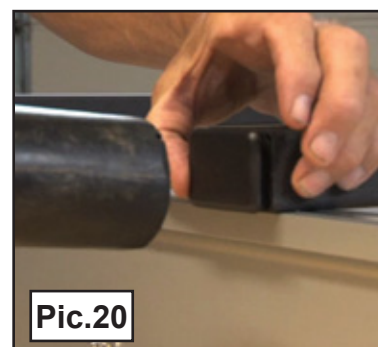
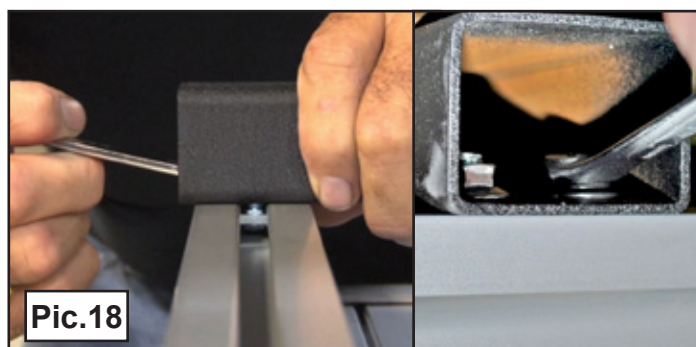

PRE-ASSEMBLY COMPLETE. PROCEED TO TRUCK BED INSTALLATION.

Jotto-Cargo Slide Installation Instructions

NOW FOR THE COMPLETE TRUCK BED INSTALLATION.

10 With a friend, place assembled Jotto-Cargo Slide into truck bed. (See Pic.21) Insert the hold down bracket into end of side support rail and slide Jotto-Cargo Slide to truck bulkhead. (See Pic.22) If riveting Jotto-Cargo Slide to truck bed, drill pilot holes for bracket attachment and use rivet gun to insert rivets (4) on each side. You may also use self-tapping screws for this step. (See Pic.23) Repeat on other side

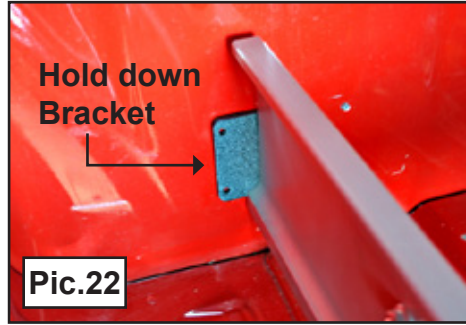

11 After setting flooring in place, position both cleat angle bars at either end of drawer. When fastened to the front drawer face and rear end cap, they will lock flooring in place.

12 Attach supplied sound dampening pads to Rear Drawer Face. The placement should align with hold down bracket and ensure pad contact. (See Pic.24)

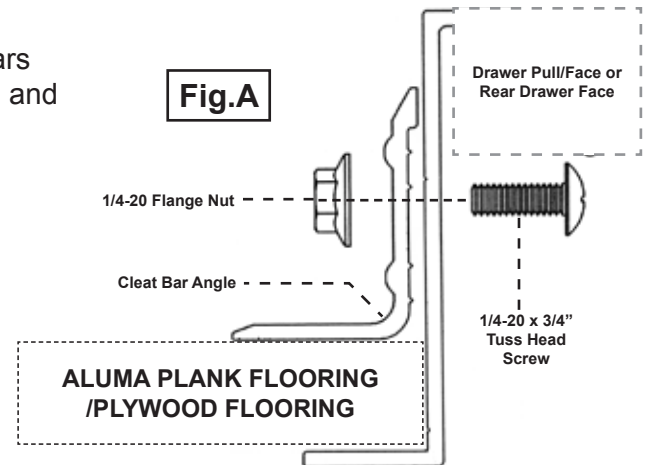

13 At tailgate end of side supports, slide pre-attached rail plate on torque plates into lower channel of support rail. (See Pic. 25) Bracket slot should face away from tailgate towards truck cab. (See Pic.26)

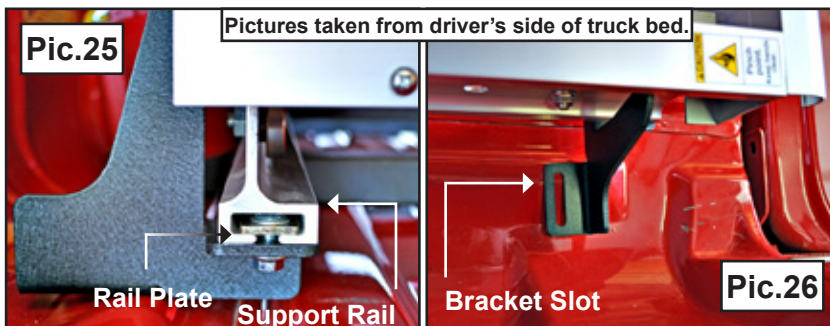

14 Attach Torque Plate by inserting Rail Plate into Frame Support Rail (See Pic.27), and slide forward until secure against Rear Frame Support Channel. Repeat on opposite side. Position Z-Bracket on a flat surface in the truck bed, aligning knob along the channel in the Torque Plate. Mark holes of Z-Bracket, tighten knob until contact made with pickup bed, marking location for drilling. Remove Z-Bracket and drill 3 Holes.



15 Insert Carriage Bolts through Z-Bracket and the holes in truck bed. (See Pic.28) Secure bracket by tightening flange nuts from underside of the truck. (See Pic.29)

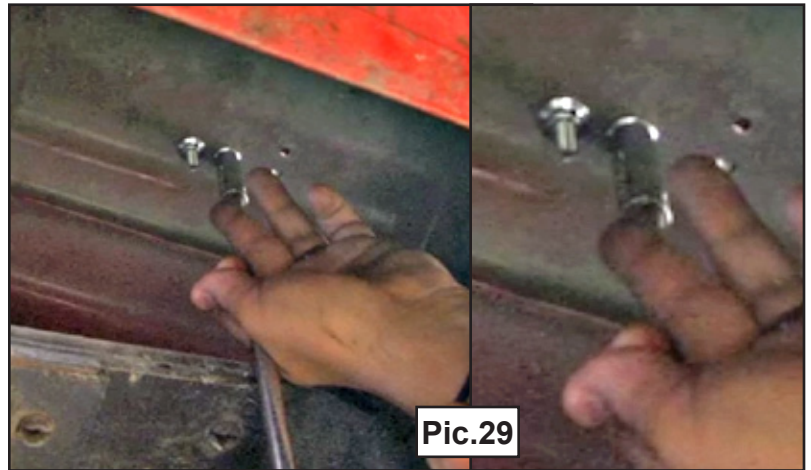

16 With Z-bracket firmly attached, screw the knob through the torque plate AND bed of pickup. Once the knob is threaded down to make contact with Z-bracket, tighten bottom flange nut onto top of torque plate. Then tighten nut down onto top of flange nut with wrench.(See Pic.30) Repeat on other side. **WARNING: THIS IS KEY AND A VITAL ASPECT TO KEEPING YOUR JOTTO-CARGO SLIDE SECURED IN YOUR PICKUP BED.**

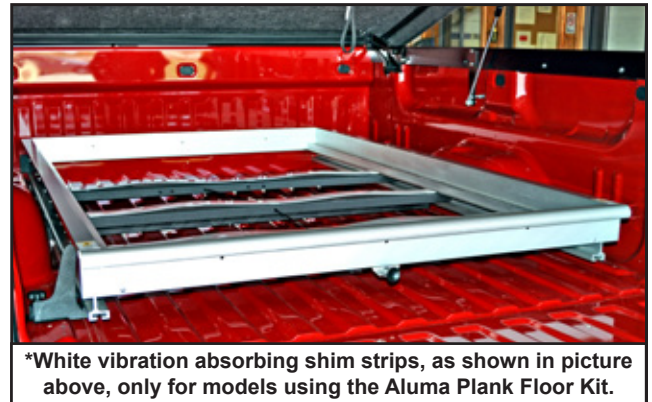
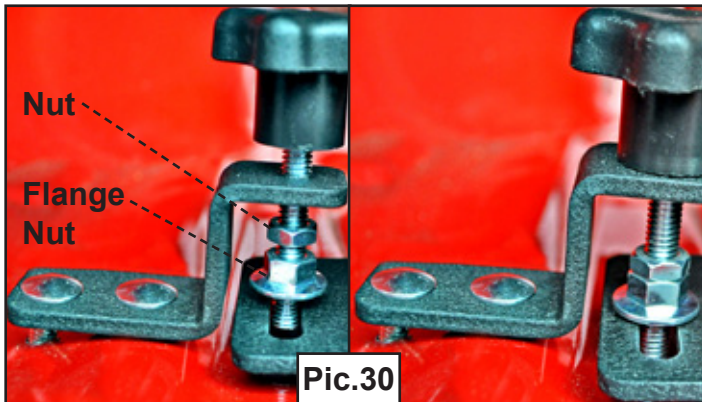

DRAWER BOTTOM - A piece of plywood 5/8" - 3/4" thick is commonly used. Cut to the size of your tray. Plywood must be cut square, either cut yourself or at your local lumber outlet.

- Full Size P/U 63" X 49": CUT 60.25" X 42.50"**
- Full Size P/U 65" X 49": CUT 62.25" X 42.50"**
- Full Size P/U 76" X 49": CUT 74.00" X 42.50"**
- Full Size P/U 80" X 49": CUT 76.00" X 42.50"**
- Full Size P/U 95" X 49": CUT 93.00" X 42.50"**
- Mid Size P/U 72" X 40": CUT 70.00" X 33.25"**
- Mid Size P/U 58" X 40": CUT 55.25" X 33.25"**

*NOTE: If your Jotto-Cargo Slide is overly exposed to the elements, we recommend a marine grade plywood or our optional Aluma Plank System.

----- WARNING -----

SEE WEIGHT DISTRIBUTION DIAGRAM
BEFORE LOADING AND USING TRAY

NO

YES

**Please Observe & Do Not Exceed
Vehicle Weight Capacity, and Use
Even Distribution with Slide!**

**Questions? Contact your local dealer or try our LIVE Online Customer Support!
For additional questions call 877-455-6886 - www.jottocargoslide.com**

Jotto-Cargo Slide Parts Assembly

HARDWARE BAGS: 1-3



BAG #1:
 (8) #10 Sheet Metal Screws
 (1) Square head bit
 (2) 1/4-1.5" Slotted Screws
 warranty card
 instruction form



BAG #2:
 (12) pop rivets
 (12) #10-16x1" tek screws
 (2) bracket hold downs
 (6) black cap plugs
 (1) e-clip
 (6) phillips head bolts
 (6) 1/4-20 Flange Nuts



BAG #3:
 (2) rear z-brackets
 (2) clover knobs
 (2) 3/8" wiz flange nuts
 (2) 5/16" wiz flange nuts
 (2) 5/16" hex nut
 (2) radial bearings
 (4) 1/4-20 carriage bolts
 (4) 1/4-20 flange nuts
 (4) foam pads

FRAME ASSEMBLY



FRAME SIDE RAILS (2)



FRAME SUPPORT RAILS (3)



SUPPORT BRACKETS (2)

DRAWER ASSEMBLY



DRAWER SIDE RAILS (2)



DRAWER PULL / FACE (Tailgate Side)



REAR DRAWER FACE (Bulkhead Side)



FRONT AND REAR FLOOR CLEATS (2)



TRAY CROSS CHANNELS (3)



LATCH CONTROL CABLE



PULL HANDLE

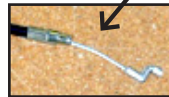

DOG LEG



RADIAL BEARINGS (2)



END CAPS (6)

FINAL ASSEMBLY



TORQUE PLATES (2) - (BAG #4)

Questions? Contact your local dealer or try our LIVE Online Customer Support!
For additional questions call 877-455-6886 - www.jottocargoslide.com